



essential

essential

when 3D becomes a trend

Emotional surfaces

Write the Untold story of your space...

Minimal, romantic, retro or modern fusion,
Which is yours?

ESSENTIAL

when 3D becomes a trend

Essential is a state of mind; trendy, subtle,
contemporary.

What is your mind like? Here 5 reasons to
change your mind: Noudel, wicker, Leaf,
wedge and Inset.

Sinuous shapes and geometries, free style for
your desired home character.

Neutral soothing colours : white, cotton, soft
grey and a touch of character with a
sassy black.

Emotional surfaces

Escribe la historia jamás contada de tu propio
espacio...

Fusiona lo minimalista, romántico, moderno
o retro, ... ¿Cuál es la tuya?

ESSENTIAL

when 3D becomes a trend

Essential es un estado de animo, de tendencia,
sutil, contemporáneo.

Como te sientes?... Te proponemos 5 razones
para cambiar de parecer: Noudel, wicker,
Leaf, wedge e Inset.

Formas sinuosas y geometrías, siéntete libre
de darle a tu hogar tu propia personalidad.

Colores neutros y relajantes: white, cotton,
gris suave y un tono negro grafito descarado.

WOW

CON- TENTS



18

LEAF
5" · 5" / 12,5 · 12,5 cm
LEAF L
10" · 10" / 25 · 25 cm



44

INSET
5" · 5" / 12,5 · 12,5 cm
INSET M
5" · 10" / 12,5 · 25 cm
INSET L
10" · 10" / 25 · 25 cm

WEDGE
5" · 5" / 12,5 · 12,5 cm

04



50

URBAN
5" · 5" / 12,5 · 12,5 cm
URBAN M
5" · 10" / 12,5 · 25 cm



NOUDEL
5" · 5" / 12,5 · 12,5 cm
NOUDEL L
5" · 5" / 25 · 25 cm

28

**NOUDEL DECOR
B&W**
5" · 5" / 12,5 · 12,5 cm

38

WICKER
5" · 5" / 12,5 · 12,5 cm

12



**TECHNICAL
FEATURES**
Características
técnicas

54

WEDGE

5" · 5" / 12,5 · 12,5 cm

Available colours

Colores disponibles



White
Matt

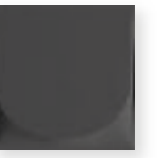

Black
Matt



White
Gloss

WEDGE

5" · 5" / 12,5 · 12,5 cm

- White Gloss



WEDGE
5" · 5" / 12,5 · 12,5 cm
- White Gloss

URBAN
5" · 5" / 12,5 · 12,5 cm
- White Gloss

Composition
Composición



White Gloss
34 %

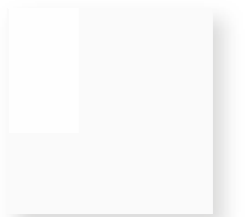

URBAN
White Gloss
66 %



Composition
Composición



White Matt

WEDGE
5" · 5" / 12,5 · 12,5 cm
- White Matt



WEDGE
5" · 5" / 12,5 · 12,5 cm
- Black Matt

URBAN
5" · 5" / 12,5 · 12,5 cm
- Black Matt

Composition
Composición

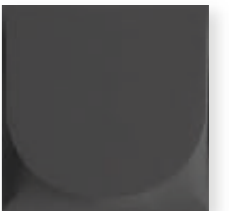

Black Matt
34 %



URBAN
Black Matt
66 %

WICKER

5" · 5" / 12,5 · 12,5 cm

WICKER

5" · 5" / 12,5 · 12,5 cm
- White Gloss

Available colours

Colores disponibles



White
Matt

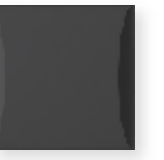

Black
Matt



White
Gloss



WICKER
5" · 5" / 12,5 · 12,5 cm
- Black Matt

Composition
Composición



Black Matt

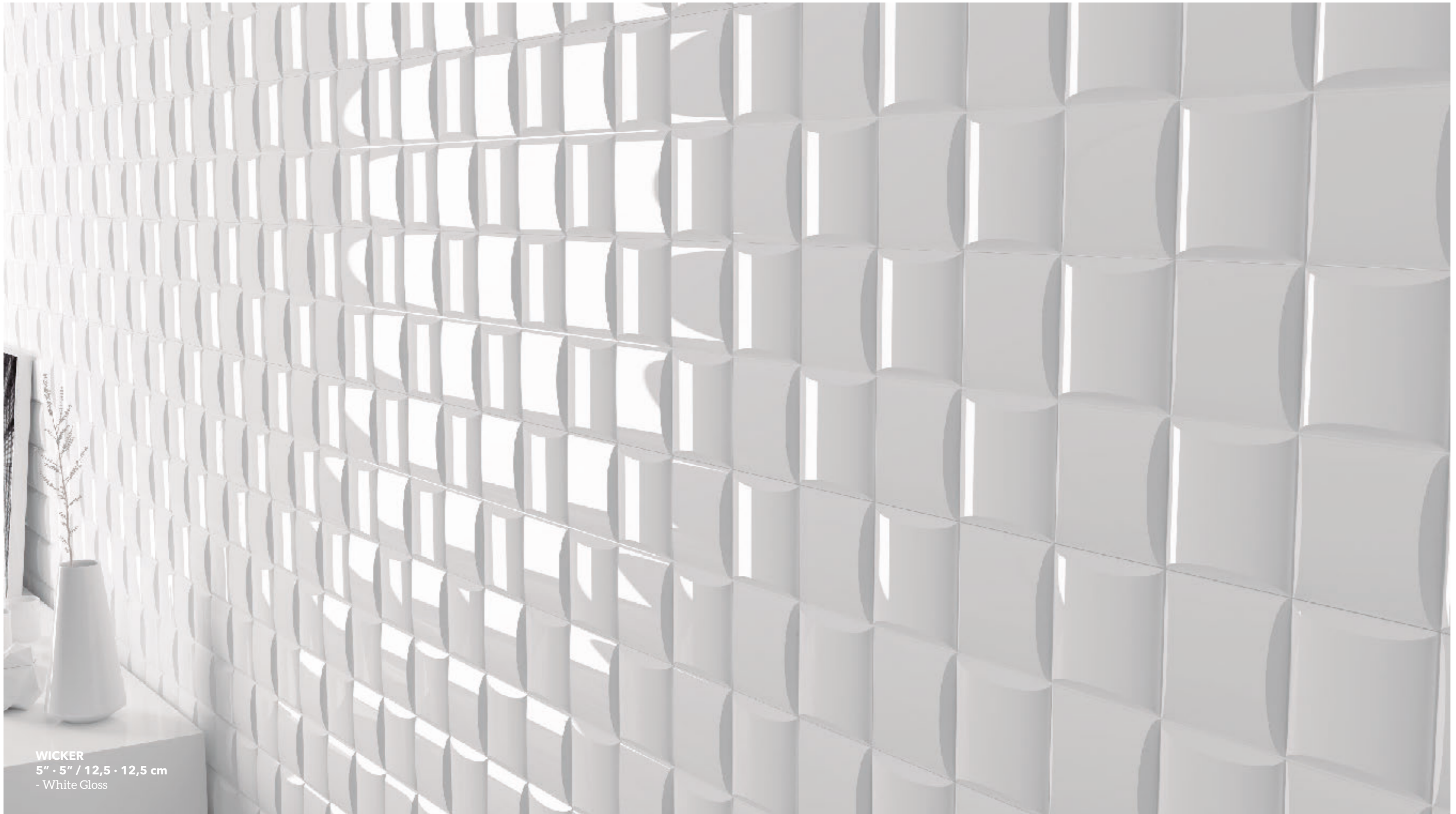

WICKER
5" · 5" / 12,5 · 12,5 cm
- White Gloss

Composition
Composición



White Gloss

LEAF

5" · 5" / 12,5 · 12,5 cm

LEAF

5" · 5" / 12,5 · 12,5 cm

- White Gloss

Available colours

Colores disponibles



White
Matt



Black
Matt



White
Gloss



LEAF
5" · 5" / 12,5 · 12,5 cm
- White Matt

Composition
Composición



White Matt

LEAF L

10" · 10" / 25 · 25 cm

LEAF L

10" · 10" / 25 · 25 cm
- Black Matt

Available colours

Colores disponibles



White
Matt



Black
Matt



White
Gloss



Composition
Composición



White Matt

LEAF L
10" · 10" / 25 · 25 cm
- White Matt

NOUDEL

5" · 5" / 12,5 · 12,5 cm

Available colours

Colores disponibles



White
Matt

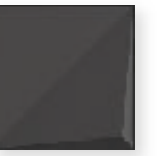

Black
Matt



White
Gloss

NOUDEL

5" · 5" / 12,5 · 12,5 cm

- White Gloss



Composition

Composición



White Matt
34 %

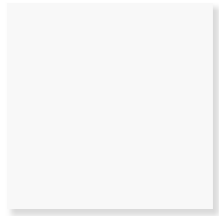

URBAN
5" · 5" / 12,5 · 12,5 cm
White Matt
66 %

NOUDEL
5" · 5" / 12,5 · 12,5 cm
- White Matt

URBAN
5" · 5" / 12,5 · 12,5 cm
- White Matt

NOUDEL L

10" · 10" / 25 · 25 cm

Available colours

Colores disponibles



White
Matt

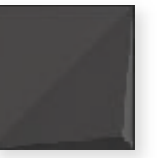

Black
Matt



White
Gloss

NOUDEL

10" · 10" / 25 · 25 cm

- White Matt



NOUDEL L
10" · 10" / 25 · 25 cm
- White Matt

Composition
Composición



White Matt

NOUDEL DECOR B&W

5" · 5" / 12,5 · 12,5 cm

SIX DIFFERENTS PATTERNS

Seis modelos diferentes



White
Matt

NOUDEL DECOR B&W

5" · 5" / 12,5 · 12,5 cm

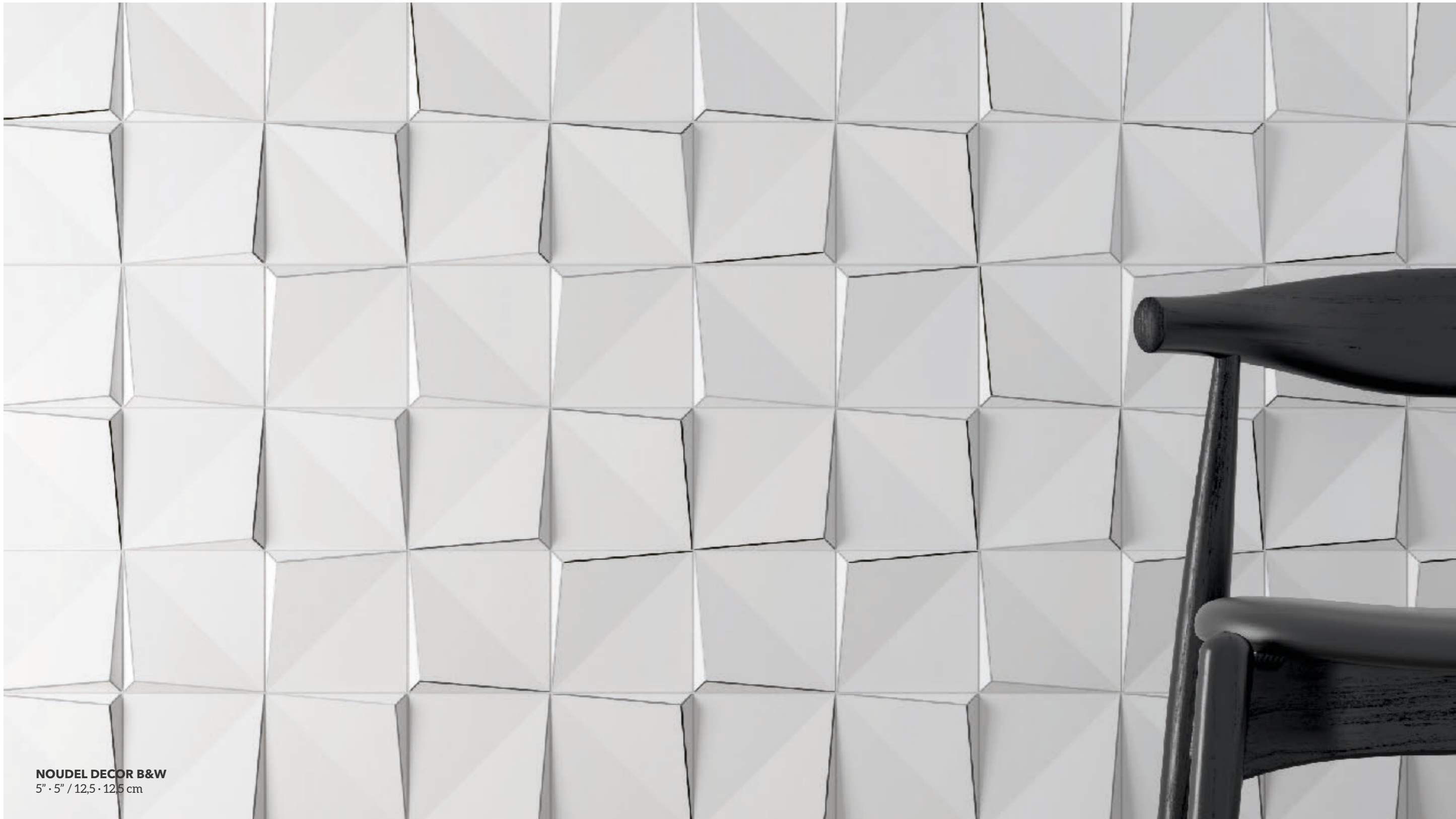

NOUDEL DECOR B&W
5" · 5" / 12,5 · 12,5 cm

Composition
Composición



White Matt



NOUDEL DECOR B&W
5" · 5" / 12,5 · 12,5 cm

Composition
Composición



White Matt

INSET - INSET M - INSET L

5" · 5" / 12,5 · 12,5 cm

5" · 10" / 12,5 · 25 cm

10" · 10" / 25 · 25 cm

INSET

5" · 5" / 12,5 · 12,5 cm

- Black Matt 50 %

INSET M

5" · 10" / 12,5 · 25 cm

- Black Matt 30 %

INSET L

10" · 10" / 25 · 25 cm

- Black Matt 20 %

Available colours

Colores disponibles



White
Matt



Black
Matt



White
Gloss



INSET - INSET M - INSET L
5" · 5" / 12,5 · 12,5 cm
5" · 10" / 12,5 · 25 cm
10" · 10" / 25 · 25 cm
- White Matt

Composition
Composición

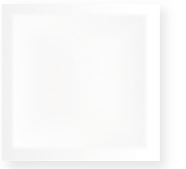

White Matt
50 %

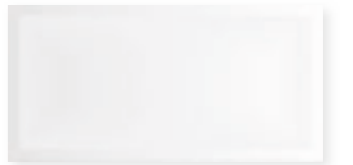

White Matt
30 %



White Matt
20 %



INSET - INSET M - INSET L
5" · 5" / 12,5 · 12,5 cm
5" · 10" / 12,5 · 25 cm
10" · 10" / 25 · 25 cm
- Black Matt

Composition
Composición



Black Matt
50 %



Black Matt
30 %



Black Matt
20 %

URBAN - URBAN M

5" · 5" / 12,5 · 12,5 cm

5" · 10" / 12,5 · 25 cm

URBAN M

5" · 10" / 12,5 · 25 cm

- White Gloss 80 %

WEDGE

5" · 5" / 12,5 · 12,5 cm

- White Gloss 20 %

Available colours

Colores disponibles

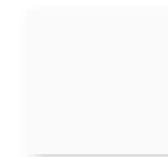

White
Matt



Black
Matt



White
Gloss



EDGE URBAN
0,3" · 10" / 0,8 · 25 cm
- White Matt

EDGE CORNER URBAN
0,3" · 0,3" · 0,3" / 0,8 · 0,8 · 0,8 cm
- White Matt

WICKER
5" · 5" / 12,5 · 12,5 cm
- White Matt

COMPLEMENTARY PIECES

Piezas complementarias

EDGE URBAN
0,5" · 10" / 0,8 · 25 cm



EDGE CORNER URBAN
0,3" · 0,3" · 0,3" / 0,8 · 0,8 · 0,8 cm



Available colours

Colores disponibles



White
Matt



Black
Matt



White
Gloss

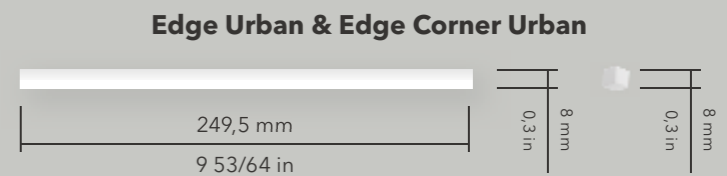
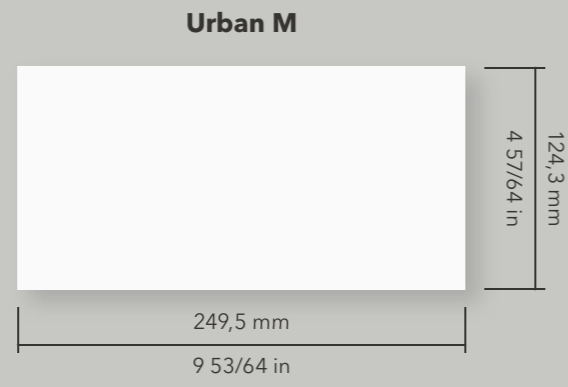
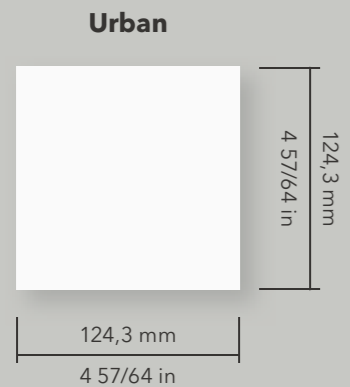
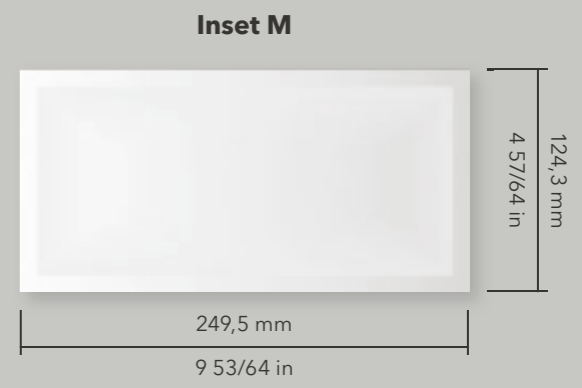
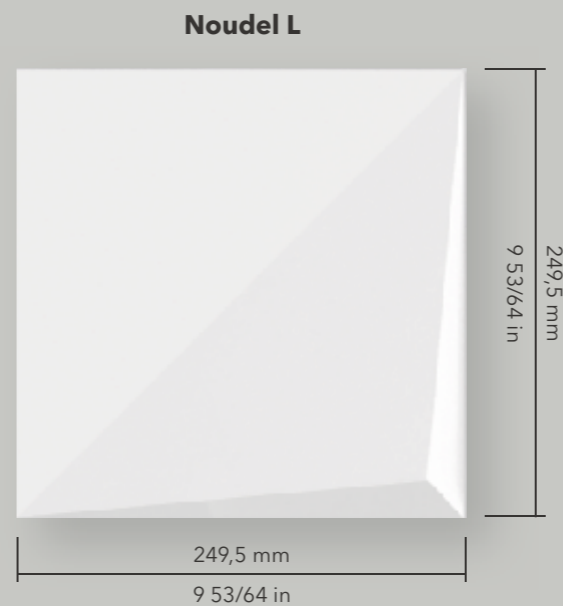
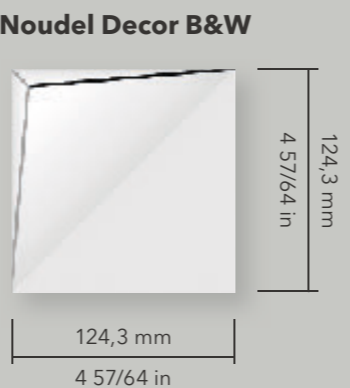
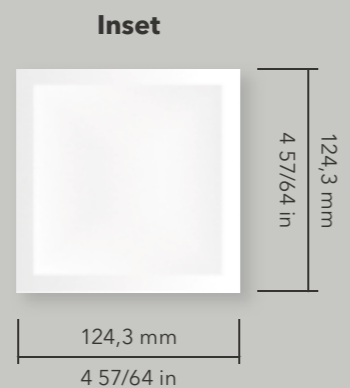
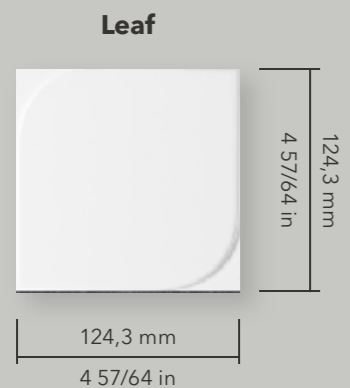
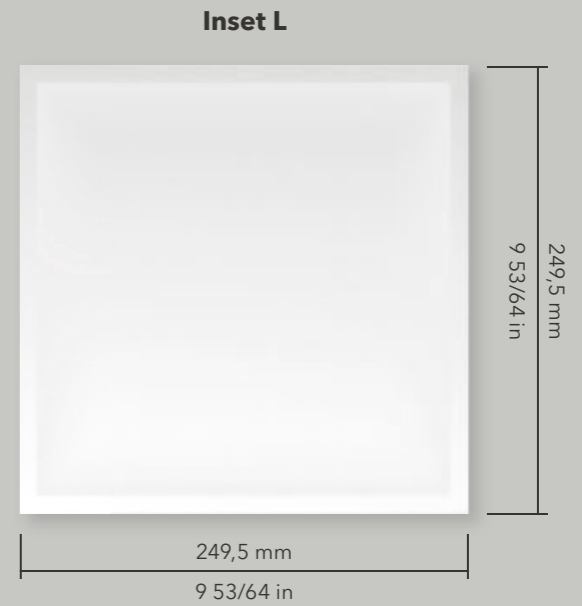
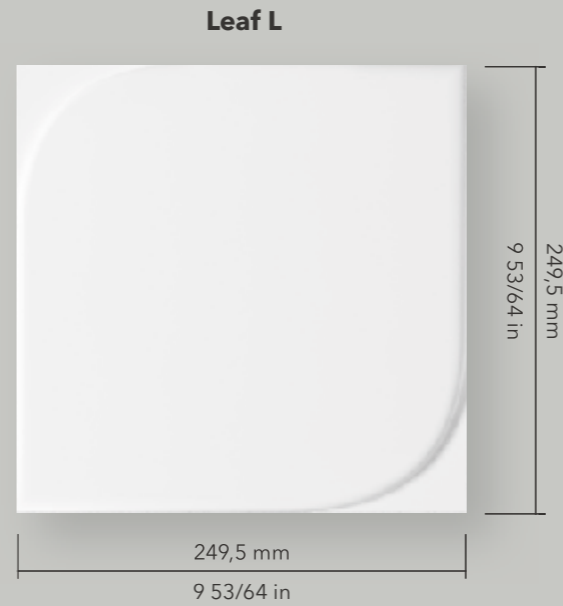
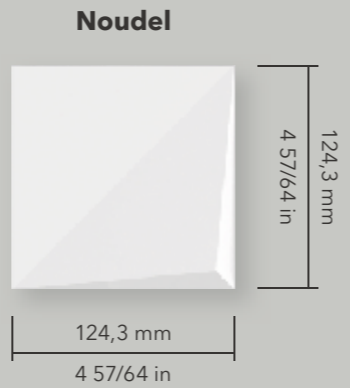
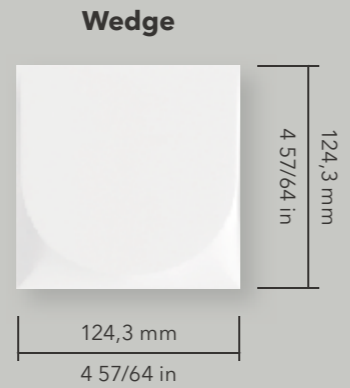
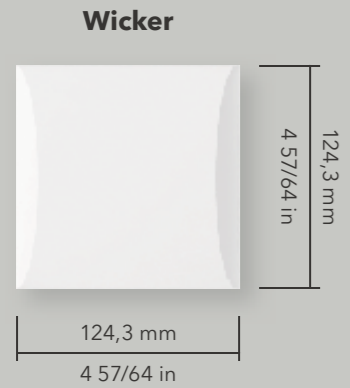

Modelo Model	Tamaño (cm) Size (cm)	Piezas/caja Pieces/box	kg/caja kg/box	m²/caja m²/box	cajas/palet box/pallet	m²/palet m²/pallet
Inset	12,5x12,5	38	6,35	0,587	85	49,895
Wedge	12,5x12,5	26	6,65	0,402	85	34,170
Leaf	12,5x12,5	28	6,47	0,433	85	36,805
Wicker	12,5x12,5	28	7,30	0,433	85	36,805
Noudel	12,5x12,5	28	6,97	0,433	85	36,805
Inset M	12,5x25	38	12,80	1,179	48	56,592
Inset L	25x25	18	12,14	1,121	48	53,808
Leaf L	25x25	12	13,70	0,748	48	35,904
Noudel L	25x25	13	13,28	0,810	48	38,880
Noudel Decor B&W	12,5x12,5	28	6,97	0,433	85	36,805







FIELD TILES

Urban	12,5x12,5	38	8,91	0,587	85	49,895
Urban M	12,5x25	38	17,86	1,179	48	56,592
Edge Urban	0,8x0,8x25	10	0,35	2,495 m	-	-
Edge Corner Urban	0,8x0,8x0,8	-	-	-	-	-

Model	Size (in)	Pieces/box	lb/box	sq ft/box	boxes/pallet	ft²/pallet
Inset	5x5	38	14.00	6.318	85	537.030
Wedge	5x5	26	14.66	4.327	85	367.795
Leaf	5x5	28	14.26	4.661	85	396.185
Wicker	5x5	28	16.09	4.661	85	396.185
Noudel	5x5	28	15.37	4.661	85	396.185
Inset M	5x10	38	28.22	12.691	48	609.168
Inset L	10x10	18	26.76	12.066	48	579.168
Leaf L	10x10	12	30.20	8.051	48	386.448
Noudel L	10x10	13	29.28	8.719	48	418.512
Noudel Decor B&W	5x5	28	15.37	4.661	85	396.185

FIELD TILES

Urban	5x5	38	19.64	6.318	85	537.030
Urban M	5x10	38	39.38	12.691	48	609.168
Edge Urban	0.3x0.3x10	10	0.77	8.186 Lft	-	-
Edge Corner Urban	0.3x0.3x0.3	-	-	-	-	-

Technical features for Dry-Pressed ceramic tiles with water absorption BIII (Eb >10%) Características técnicas para las baldosas cerámicas prensadas en seco del grupo BIII (Eb >10%)		
FEATURES / CARACTERÍSTICAS	SPECIFICATION / ESPECIFICACIÓN	NORMA
 Dimensional Features	124,3 +/- 0.6 x 124,3 +/-0.6 mm 124,3 +/- 0.6 x 249,5 +/-0.6 mm 249,5 +/- 0.6 x 249,5 +/-0.6 mm	UNE-EN ISO 10545-2:1998
 Water absorption	$E_b > 10\%$	UNE-EN ISO 10545-3:1997
 Modulus of rupture and breaking strength	Thickness $\leq 7,5$ mm mínimo 15 N/mm ² Thickness $> 7,5$ mm mínimo 12 N/mm ²	UNE-EN ISO 10545-4:2012
 Crazing resistance	Pass	UNE-EN ISO 10545-11:1997
 Household products resistance	GA	UNE-EN ISO 10545-13:1998
 Chemical resistance	GHA	UNE-EN ISO 10545-13:1998
 Stain resistance	Class 5	UNE-EN ISO 10545-14:1998

WAREHOUSING

In order to guarantee the characteristics of the finish the product must be kept in its original packaging until the time of fixing. If the product is likely to be stored for a long period of time it should be suitably covered.

TILE FIXING

To ensure the products adhere correctly to the surface, it is essential to use specific adhesive and grouting material. This must also be suitable for the environment they will have to withstand. Fitting with traditional mortars does not ensure good adhesion.

To remove the protective wax in the glazed surface of the tiles, use only warm water and a damp cloth.

All types of joints must be planned and carried out correctly: structural, perimeter, expansion and installation joints. Fitting tiles without joints is not advisable from any technical point of view as this may lead to various problems. For an optimal result, we advise to use 1 mm (0 5/64 in) grout for Inset and modular compositions and 1,5 mm (0 1/16 in) for the rest.

MAINTENANCE AND CLEANING

Once the materials have been fitted, it is advisable to remove any remaining adhesive and grouting material by using a commercial descaling product designed especially, diluted with water. The descaling product must not remain in contact with the surface to be cleaned for more than 5 minutes.

As a general guideline, powder detergents should not be used, not wire wool or abrasive materials. Generally a sponge will be sufficient with warm water and liquid neutral soap. Then rinse with plenty of clean water.

ALMACENAMIENTO

Para garantizar las características de su acabado, el producto debe mantenerse en su embalaje original hasta el momento de la colocación. Si el producto va a permanecer almacenado durante un largo periodo es conveniente hacerlo bajo cubierta.

COLOCACIÓN

Para garantizar una buena adhesión al soporte es necesaria la utilización de materiales de agarre y de rejuntado adecuados al ambiente al que vayan a estar sometidos. La colocación con morteros tradicionales no garantiza una buena adhesión.

Para retirar la cera protectora de las piezas en la superficie esmaltada, es suficiente con agua tibia y un paño húmedo.

Deberán planificarse y ejecutarse correctamente todo tipo de juntas: estructurales, perimetrales, de dilatación y de colocación. La colocación sin juntas es desaconsejable desde cualquier punto de vista técnico, pudiendo ser el origen de diversas patologías. Para un resultado óptimo, recomendamos usar 1 mm de junta para el modelo Inset y para todas las composiciones modulares. En el resto de casos recomendamos utilizar 1,5 mm.

MANTENIMIENTO Y LIMPIEZA

Finalizada la puesta en obra se recomienda eliminar los restos de materiales de agarre y rejuntado con un desincrustante comercial diseñado expresamente para baldosas cerámicas, rebajado con agua, permaneciendo en contacto con la superficie a limpiar no más de 5 minutos.

Como norma general no deben utilizarse detergentes en polvo ni estropajos metálicos o abrasivos. Generalmente será suficiente con una esponja, agua tibia y un jabón líquido neutro. Posteriormente aclarar con abundante agua limpia.

Designed by



Polígono Pont, Avda. de España 114
12180 Cabanes,
Castellón (Spain)
t. +34 964 331 910 / f. +34 964 331 911

wowdesigneu.com

info@wowdesigneu.com
comercial@wowdesigneu.com

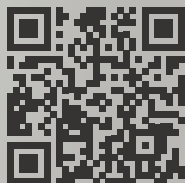

©2017 Tendencias Cerámicas

WOW, registered trademark of Tendencias Cerámicas, S.L.

The brand use or reproduction of the contents of this catalog, is protected by copyright law. Any use of the brand or reproduction thereof, in part or total, must be authorized by Tendencias Cerámicas, S.L. Otherwise, this action can be sanctioned according to the Law.

©2017 Tendencias Cerámicas

WOW, marca registrada por Tendencias Cerámicas, S.L.

La utilización de la marca o la reproducción del contenido de este catálogo está protegida por la Ley de Propiedad Intelectual. Cualquier uso de la marca o la reproducción del mismo, en parte o en su totalidad, debe ser autorizada por Tendencias Cerámicas, S.L., pudiendo, en caso contrario, ser esta acción sancionada de acuerdo con la Ley.

WOW reserves the right to modify and/or discontinue certain models displayed in this catalogue.

The colour of the pieces displayed herein may differ slightly from originals.

The settings shown in this catalogue are design proposals for advertising purposes.

In real situations in which the pieces are laid, the installation instructions published by WOW should be followed.

WOW se reserva el derecho de modificar y/o suprimir ciertos modelos expuestos en este catálogo sin previo aviso.

Los colores de las piezas pueden presentar ligeras diferencias respecto a las originales.

Los ambientes que se muestran en este catálogo son sugerencias decorativas de carácter publicitario, debiéndose utilizar en la instalación real las instrucciones de colocación editadas por WOW.